



CDI+ Ignition System Manual

Issue 3.4



(CDI+ unit in refurbished Bosch case)

Table of Contents

Thanks!.....	4
CDI+ Ignition Upgrade.....	4
CDI+ Benefits.....	4
Design.....	4
What about more horsepower?	6
Dyno results	7
Before You Start.....	8
Packing List.....	8
'Baseline' the Ignition timing.	9
Installing the CDI+ unit.....	9
First Engine Start.....	11
Tacho wiring for 3 pin CDI+ units.....	11
Model Years 1969 - 1972	12
Model Years 1973 - 1977	14
Model Years 1978 - 1988	14
Shift light wiring (all CDI+ units).....	14
Switch /Clutch Input (all CDI+ units)	14
'Jogwheel' Functions	16
Mode 1 - Tacho Test	16
Mode 2 - Max Rpm (Hard Rev Limit Adjust)	16
Mode 3 - Shift Light Rpm	16
Mode 4 - Tacho Cal	16
Advanced Setup	17
Software Installation.....	17
Software Features.....	18
Live Tacho	19
Live Engine Readback.....	20
Profile Settings	21
Reading a Profile from the CDI+ unit.	21
Creating a new Profile.....	22

Deleting a Profile.....	22
Settings in Detail	22
Trig Advance.....	22
Rpm Hard Limit	22
Hard Limit cut.....	22
Rpm Soft Limit.....	22
Soft Limit Adv	22
Rpm Shift Light.....	23
Launch Limit	23
2nd Spark After	23
Input Delay Adj.....	23
Advance Curve Plot.....	24
Adjust Room.....	25
Ignition timing schemes.....	25
Overlay mode.....	25
Full Control mode.	26
Vacuum Advance.	28
Distributor Locking Collet.....	29
Advance Timing Results	31
Troubleshooting.....	32
Disclaimer.....	32

Thanks!

Thank you for purchasing our CDI+ upgrade for your 911. We hope you like it! The CDI+ is just one of many products we are developing.

CDI+ Ignition Upgrade.

The 911-CDI+ is an essential upgrade for all Porsche 911s fitted with Bosch Capacitive Discharge Ignition. This spans 1969 to 1983 and up to 1989 for most Turbo models. The highlights of the system are:

- Completely redesigned modern electronics.
- Plug and play with no wiring changes.
- Double spark at all RPMs.
- Programmable Ignition curve and rev limiters
- Simple installation.

Dependent on your model year, you will have either a 3 pin (early) box or a 6 pin (late) box. Both models have the same features.

The CDI+ unit comes in either a CNC machined case or in a refurbished original Bosch case. Both units have the same functionality.

CDI+ Benefits

Design

The 911-CDI+ has been developed specifically for the Porsche 911.

We set out to produce a high reliability plug and play solution of the Bosch CDI system. The electronics have been designed to run cool for a long life and modern regulation and protection circuitry has been incorporated. The circuitry has been matched to the existing components, namely coil, leads and distributors to ensure it will 'just work'. Many aftermarket ignition boxes, overdrive the voltage to the coil that can lead to a short coil life.

When we started to put the units on cars, we had some unexpected results. Over the course of 2 years we have run a number of 'test mules', from 2.0 litre race cars on carburetors, to 2.7 MFI, 2.8 twin spark and a number of stock 3.0 SCs.

We repeatedly had reports of improved drive-ability, less hesitation, improved 'smoothness'. In the 2.0 litre race car, engine 'pick up' was much improved. MFI cars with 2000 - 3000 RPM hesitation - gone. Jerky CIS cars at low speed now ran smooth.

As engineers, we did not want to provided subjective and anecdotal evidence so we needed to understand why this would happen. We looked at the original CDI design more closely and compared it to CDI+:

Design	Classic Retrofit CDI+	Bosch CDI/ HKZ
High Voltage Power Supply	Constant 300V output for input voltages 9 - 16V across entire rev range.	Variable output dependent on input voltage and RPM. 400V @ 1000 RPM degrading to 240V @ 6000 RPM
Spark output	2 sparks back to back at programmable intervals (typically 400us)	Single spark
Input Trigger	Software compensated for delays in input circuitry. Accuracy better than 0.1 degree @ 10000 RPM.	R/C filter. Measured accuracy approximately +/- 2.5 degrees varying with RPM.
Input Circuit	Dedicated input IC.	Discrete components
Noise immunity	PCB ground plane. Input Isolation.	No ground plane.
Protection	Over voltage, reverse polarity, short circuit.	None.

We believe that many of the 'smoothness' reports of our CDI+ are down to the constant voltage delivered to the coil at all engine speeds. Combined with the second spark, the likelihood of good fuel ignition is improved particularly when the throttle is applied sharply. In this case, a single weak spark stands a chance to be extinguished by the fuel.

We have seen many original Bosch units that will run an engine but fail on our test equipment. Often a spark is produced at idle and it will run a car. On closer inspection the output voltage is lower than expected. As the RPM rises, it gets progressively less and the spark gets weaker.

Secondly, we have Bosch units that have failed input trigger circuitry. Again, they will run an engine in a fashion, but the trigger can 'miss' or the spark not be fired at the correct time.

What about more horsepower?

The CDI+ product has been designed to provide a consistent spark(s) and accurate timing. Any HP increase will initially be a side effect of improvement over the Bosch system. Given that most Bosch units are over 30 years old, there is also a high probability that the Bosch unit is not performing as it did when it was new.

Beyond that, the CDI+ units can be mapped to provide a faithful delivery of Porsche's intended ignition curve where old distributor weights and springs are no longer accurate.

The original ignition advance provided by the distributor was often designed against the poor fuel of the time. Today's higher octane fuel can allow the engine to be advanced further without risk of detonation. In some vehicles, the manufacturer's safety margin was also erring on the side of caution. The CDI+ in the hands of a competent engine specialist allows the optimum engine timing to be achieved. The CDI+ also allows ignition timing maps that are physically impossible to achieve by mechanical means.

In modified engines, the standard ignition curves will almost certainly not be optimal. Distributors can be re-curved but this is a long winded and costly cycle. Using the CDI+ on a rolling road / dyno allows changes to the timing curve to be applied instantly with immediate results.

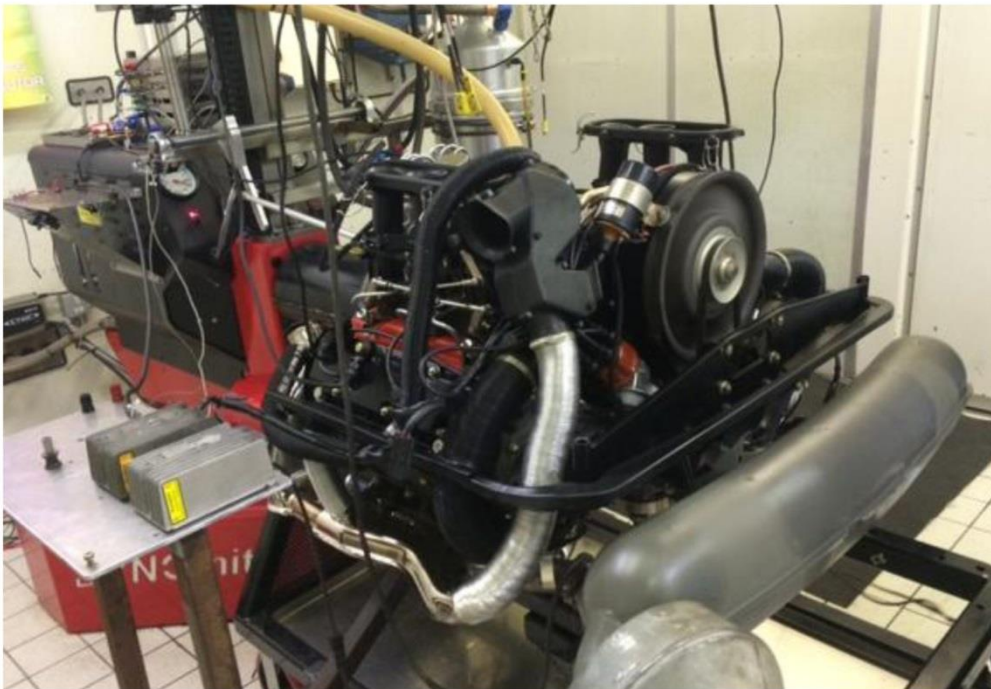

CDI+ and Bosch CDI back to back test on 2.7 RS Motor

Dyno results

In the following dyno plot, the blue line with the diamond shaped points is the advance applied by a standard bosch distributor. The data with the thick lines correspond to that run. It can be seen that around 4500 RPM, when the engine 'comes on cam', the HP and torque starts to fall.

Overlaid on the plot is the CDI+ with an adjusted curve - the blue line with the starred points. The data with the thin lines corresponds to this run. Note how the HP and torque no longer fall away so much 4500 RPM. The additional 15HP at 4500 RPM would be a noticeable improvement and certainly something you could 'feel'.

More work is required on this engine, however. It can be seen that the advance was rather 'over ambitious' at 3500 RPM resulting in less power. This is easily corrected, however, with the CDI+ mapping software.

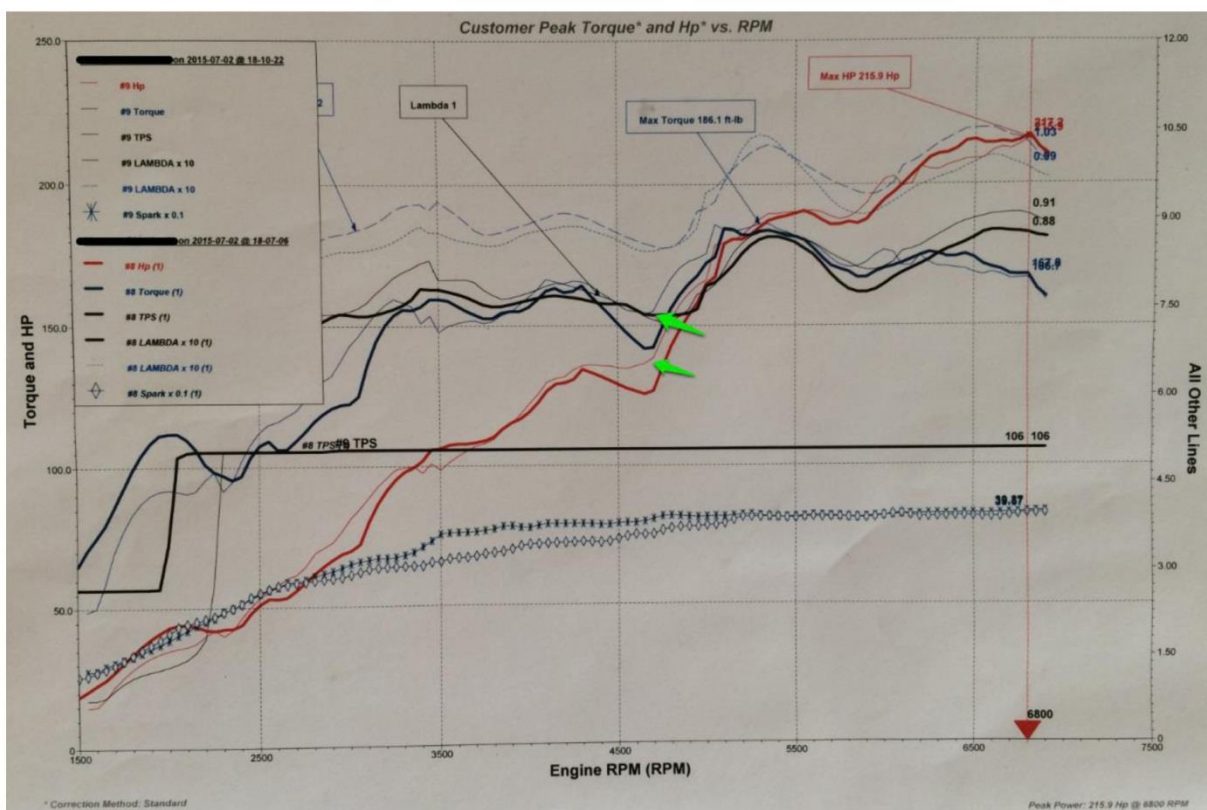

Dyno plot of CDI+ with custom ignition curve vs standard curve



The CDI+ unit produces a high voltage output (300V) to the vehicle coil.

Please consider your and other people's safety before installation.

Disconnect the vehicle battery before installation!

Before You Start

The installation is straightforward and can be completed comfortably within 1 hour by a competent person if the standard settings are used. Advanced setup of timing curves will take longer and really needs a rolling road or dyno to closely monitor engine parameters.

We do, however, draw your attention to our disclaimer at the end of this document.

There are a few wiring peculiarities with some models. Please see the sections at the end of this document.

You will need the following tools:

- A 6mm 'allen' key - preferably with a 'T' handle
- A small (4mm or less) flat screw driver for adjustment.
- Crimp connectors and crimp tool (if you are installing some of the options).
- Heat shrink / insulation tape.
- Timing strobe light.

Packing List

The packing box contains the following items.

- CDI+ unit.
- USB diagnostic cable.
- Distributor locking collet and insertion/extraction tool (optional)

You are now ready to start the installation.

'Baseline' the Ignition timing.

If you are swapping the unit on a running vehicle, we advise that the timing of the car is checked **with the standard CDI box** before fitting the unit. Refer to a workshop manual for how to check ignition timing.

This is to verify that:

- The timing of the engine is as expected.
- the existing weights and springs in the distributor are functioning

Connect a timing strobe to #1 ignition lead and make a note of the timing advance at idle and also at a couple of points up the rev range. There is a table at the back of this document to record your readings.

On most 911s, the timing is typically 0 - 5 degrees advance at idle, with the advance increasing to maximum of 20 - 30 degrees by 6000 RPM. There are some exceptions but you should see the advance increase on the strobe when the engine is revved.

Note: If you have an 'intelligent' strobe with an advance feature, switch it off (or to 0 degrees) for this check.

When you are happy that the timing is correct, proceed to installation of the CDI+.

Installing the CDI+ unit.

The CDI unit is attached to an aluminium panel on the left side of the engine bay. It is advisable to take some photos for reference prior to removing the unit.

Disconnect the battery negative terminal.

Unplug the 3 or 6 pin plug from the bottom of the original CDI unit.

On earlier cars there are three allen head screws and nuts and washers behind the panel which can fall down behind the panel so be prepared. Early cars may also have earth straps sharing the mounting screws. On the anodised CNC case, the anodising must be abraded to get a good ground. 'Star' washers can be a good way to get a decent 'bite' on the metalwork.

Later cars have captive nuts on the panel so are much easier. On a later car, you may have to remove the heater pipe on the left hand side of the engine bay.

Install the CDI+ in the same way as the original.

The CDI+ unit has either a 3 or 6 pin plug which mates to the existing wiring loom. The unit also has a diagnostic cable is used for connection to a computer for setup and some flying leads.

The flying leads may vary depending on which options are fitted.

Wire Colour	Function
Red / Black	Shift / Indication light output
Yellow / Black	Clutch / Switch input
Purple / Black	Tacho drive (3 pin only)

If you wish to connect these wires, they will need to have connectors crimped to the ends. If you are not using the wires, insulate the ends and hide them away behind the mounting panel after installation.

The diagnostic lead can be tucked behind the aluminium panel or routed to one of the 30mm holes in the relay panel.

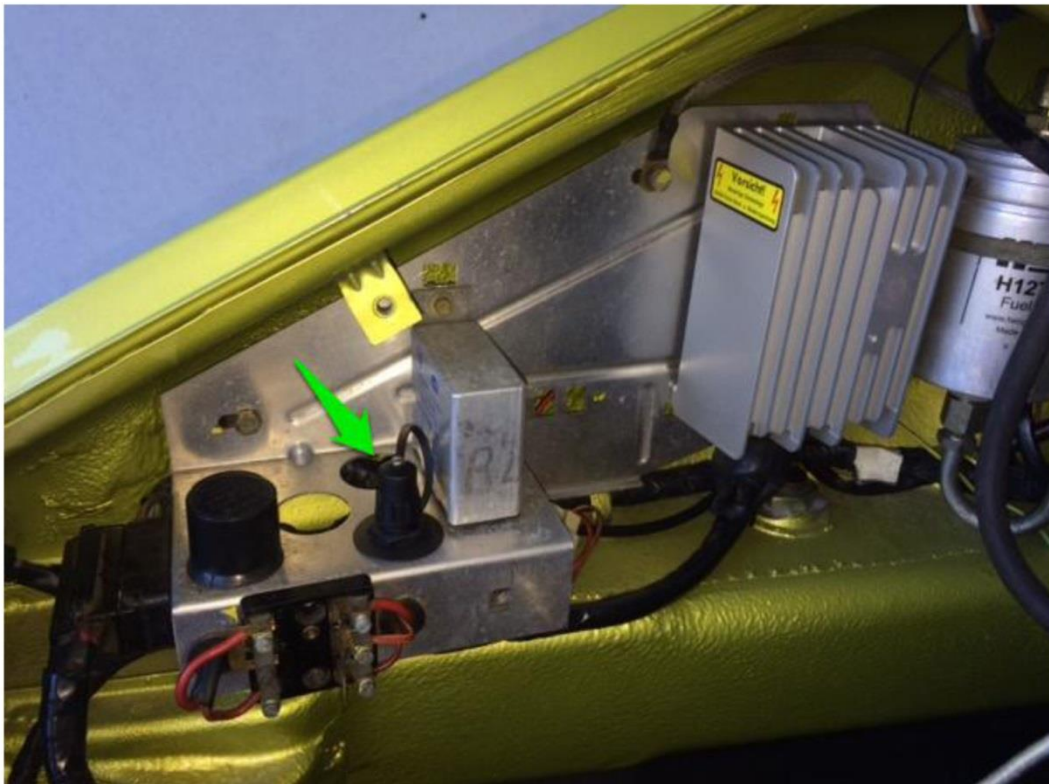

Typical installation with diagnostic connector shown in relay hole (green arrow).
(CNC machined CDI+ unit shown)

First Engine Start.

As shipped the CDI+ unit has a 'flat' ignition curve so will work with the original distributor (using the weights and springs for advance). Even if you don't intend to use the CDI+ this way, it is always worth performing this step.

Reconnect the battery and start the car. If the car does not start, slacken the distributor lock nut and turn the distributor a few mm in the direction of advance and retry.

[The CDI+ unit as shipped requires that the distributor is turned in the advance direction by 7.5 degrees. On a 3 pin car, turn the distributor anti-clockwise to advance. On a 6 pin car, turn the distributor clockwise]

Follow the workshop ignition timing procedure. Verify that the timing is the same as your initial readings with the standard unit.

You have now completed the basic setup of the unit. The timing is still controlled by the weights and springs in the distributor. The rev limiter is now controlled by the CDI+.

[If you have a mechanical rev limiting rotor arm this will still function]

Take the car for a test drive.

The car should feel the same or better. At this stage, any improvement in performance/running are attributed to the modern electronics and the double sparking scheme.

Tacho wiring for 3 pin CDI+ units.

Skip this section if you have a 6 pin CDI+ unit.

If you have completed the installation so far, your tacho will work as before but you won't be able to take advantage of some of the features of the CDI+ unit.

The CDI+ can drive the tacho independently, irrespective of the distributor RPM signal. This allows the CDI+ to use the tacho for calibration and other functions (see jogwheel functions).

In a 3 pin car the tacho drive signal is taken straight from the distributor on a purple/black wire. To allow the CDI+ unit to control the tacho, we need to intercept this signal and drive the tacho from the CDI+ unit instead.

There are a two ways of doing this, depending on the year of the car.

Model Years 1969 - 1972

Skip this section if you have a 6 pin CDI+ unit.

There are many variants of the 911 wiring and they are all slightly different. This section describes a modification that *may* be necessary but not always needed for 1969 - 1972 cars. There is every chance that the tacho will work by carrying out the simpler wiring detailed in the next section for years 1973 - 1977. **Please try this first, if it does not work, try the method described in this section.**

Between 69 and 72/3, rumour has it that Porsche had lots of tachos from earlier cars on the shelf but the drive signal was incompatible with their new CDI system. They had to use an adapter to increase the voltage level of the signal. On Porsche wiring diagrams, this is called the 'Speed Switch'

Stop! Did you try the simpler wiring scheme for 1973 - 1977 cars first? Only proceed with the following if that didn't work. The following can also be used for cars where the speed switch has failed.

This is a 2.2S with the tacho adapter highlighted (green arrow).

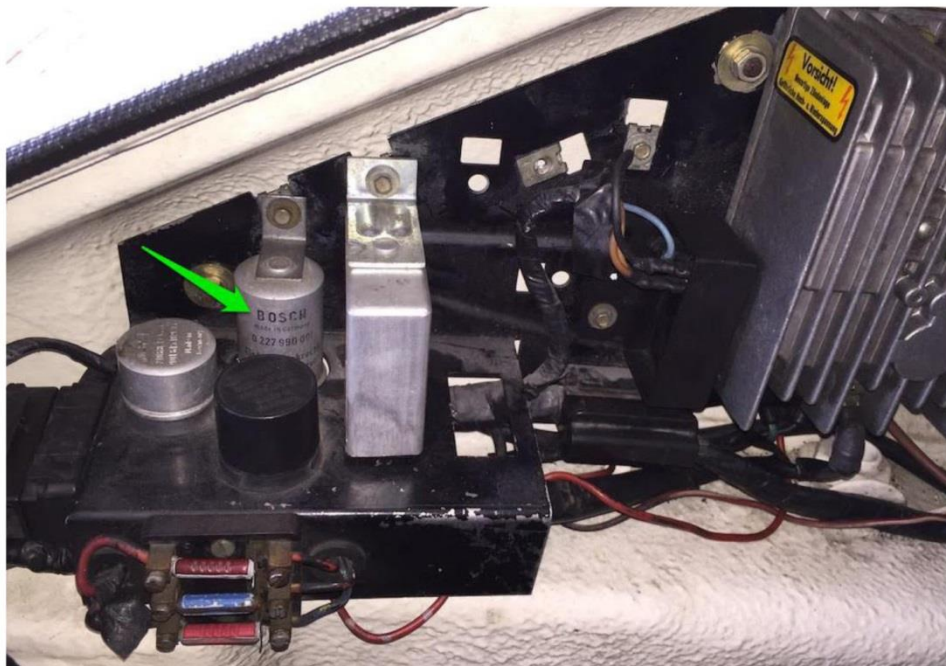

To enable the tacho to be driven from the CDI+ unit requires a couple of simple wiring changes

1) Pull the tacho out and disconnect the red/black wires from the 15 terminal (marked 12V usually). Make sure the two wires remain 'piggy-backed' together but insulate the end of the wires. Move the purple/black wire to the 15 (12V) terminal.

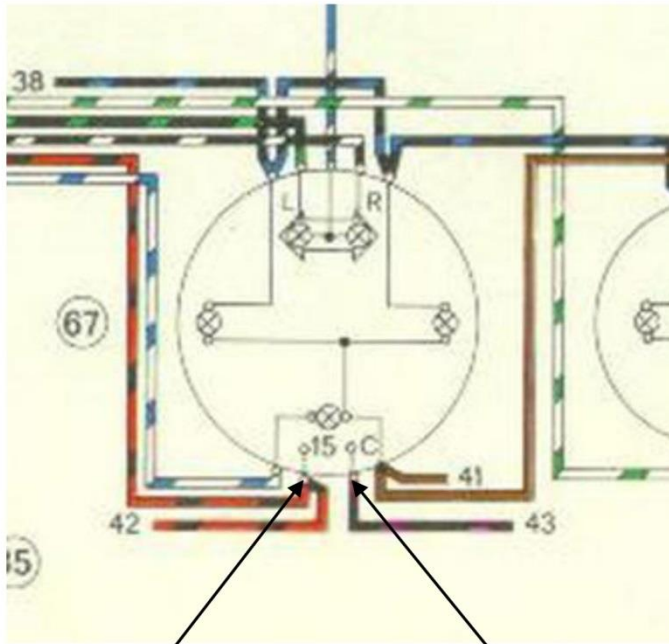

Remove red/black

Move purple/black to '15' terminal.

2) Remove the purple/black wires from terminal 4 of the tacho adapter can. There are two wires piggy-backed together, pull them apart. One wire goes to the distributor, the other to the tacho. Identify the wire that goes to the tacho. Connect the CDI+ purple/black to this wire.

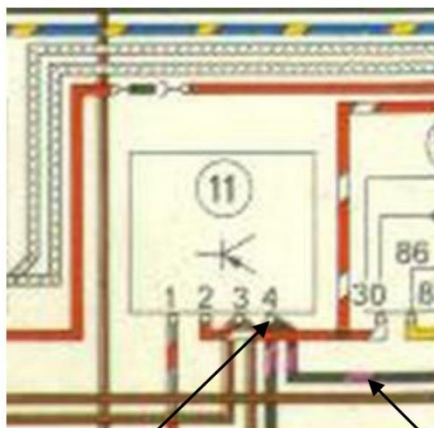

Remove purple/black

Connect CDI+ purple/black wire to this wire.

[Note. On these cars the spade terminal is at the back of the distributor and very close to an oil line. Make sure that the wires attached are still well insulated and cannot touch the oil line]

Model Years 1973 - 1977

On the back of the distributor, identify the purple/black wire. It is usually piggybacked, disconnect it from the distributor. Leave the black wire on the distributor.

Later models in this era (3.0 Carrera for example), had a two-way plastic connector between the distributor and the tacho dial. If the wire on the distributor is white (or another colour other than purple/black) trace this back to the two-way connector. You should find the purple/black tacho wire there. Extract the purple/black wire from the connector shell (it has a releasing tab that can be bend back using a small flat screwdriver).

Connect the purple/black tacho wire to the purple/black flying lead on the CDI+ unit. Insulate any connections and secure to the existing wiring.

[Note. On some cars the spade terminal is at the back of the distributor and very close to an oil line. Make sure that the black wire is still well insulated and cannot touch the oil line]

Model Years 1978 - 1988

These cars use the 6 pin CDI+ units. The tacho wiring is built in to the connector and no wiring modifications are needed.

Shift light wiring (all CDI+ units).

The red/black wire is the shift light output. It is capable of driving a led or bulb up to 5W rating.

The output is low side switching. In other words the red/black wire switches one side of the bulb to ground.

Wire up a bulb with a 12V feed to one side (If it is in the dashboard, you can piggy-pack off the tacho 12V feed).

Run a wire from the other side of the bulb, all the way back to the red/black wire on the CDI+ unit. An easy route is across the dash board, down the A pillar behind the carpet, under the left side carpet trim, up behind the rear quarter trim and through the bulkhead. For cars with heated rear screens there is a hole near the lower screen corner.

Switch /Clutch Input (all CDI+ units).

The yellow/black wire is a 'switch to ground' input. The software uses this to activate the launch rev limiter. Wire up one side of a microswitch to ground (chassis). Connect the other side to the yellow/black wire.

The microswitch can either be located on the clutch pedal or the omega spring on the gearbox. A simple bracket can be made to attach to the gearbox.

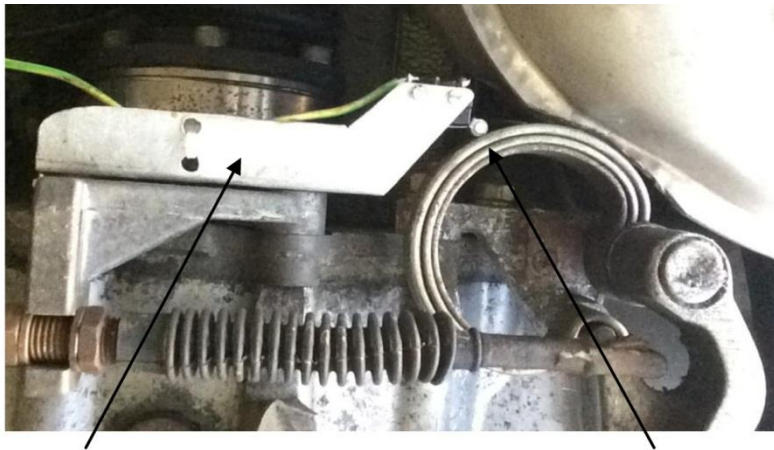

Aluminium bracket

Roller Microswitch

Note: You can use the 'INPUT' flag on the live engine readbacks in the software to test the switch (See 'live engine readback' section). Ideally, you want the flag to extinguish as soon as the clutch is fully engaged (top of pedal travel).

'Jogwheel' Functions

The unit has a small hole on the front covered by a plastic screw. Remove the screw and insert a small flat bladed screwdriver, turn gently until it seats in the slot. The internal jogwheel can turn and also can be pressed.

Four modes can be activate by pressing the jogwheel. The modes will cycle E.g. press once for mode 1, again for mode 2 etc. To access these modes the engine must be idling (under 1200 RPM). After mode 4, one more push will return the unit to normal operation. The unit will also return to normal operation if the engine is revved or the ignition switched off and on.

When a mode is selected, the LED on the top of the unit will flash according to the mode, e.g. 3 flashes for mode 3. If you have a shift light fitted, the light will also flash the mode.

Mode 1 - Tacho Test

The tacho test mode can be accessed by presssing the jogwheel once. This will start a slow 'sweep' of the tacho from 0 to 7000 RPM and back to 0 again. This mode is mainly useful for checking tacho operation, particularly when setting up a 3 pin car.

Mode 2 - Max Rpm (Hard Rev Limit Adjust)

Press the jogwheel again for mode 2. The current hard RPM limit is shown indicated on the tacho in the car. Turn the jogwheel to adjust the limiter up/down. When adjusted in this way, the soft limiter is set to 250 RPM below the hard limit as it is adjusted.

Mode 3 - Shift Light Rpm

Press the jogwheel again for mode 3. The shift light RPM is shown indicated on the tacho in the car. This is the RPM at which the light will switch on. Turn the jogwheel to adjust when you want the light to come on.

Mode 4 - Tacho Cal

Press the jogwheel again for mode 4. In this mode, the CDI+ puts calibrates the actual car tacho output for a known 6000 RPM. Adjust the jogwheel so that your tacho indicates 6000 RPM.

You can calibrate the tacho to read any value you like. Why would you want to do this?

1) You can fit any face you like to any tacho and calibrate to suit. For example, fit a 10K tacho face to a cheap SC tacho and you have a 10K tacho without having to modify the internals.

2) What about if your tacho read 4000 RPM but the engine was only doing 3500 RPM? This might have some implications for noise/emission tests.

Advanced Setup



The CDI+ unit allows configuration of ignition timing and other parameters that can be used to change the characteristics of the engine. Remember, gains in performance are almost always achieved by removing the manufacturers safety margin.

Changing these parameters may cause permanent damage to the engine.

Classic Retrofit accepts no responsibility for damage caused to engines through improper setup.

We recommend that setup of your engine is carried out by a competent installer with access to a rolling road or dyno.

If in any doubt, please contact us for an approved installer.

Access to the advanced features of the CDI+ is achieved by running the setup software on a laptop or computer. The computer is connected to the CDI+ unit using the diagnostic cable that comes with unit.

Software Installation.

Download the latest software from the Classic Retrofit website - www.classicretrofit.com.

Unzip (extract) the files to a suitable place on your computer and refer to the 'readme' file in the folder for how to setup and run the RetrofitCDI application. Run the RetrofitCDI application.

Firstly, plug in the USB cable (do not connect it to the CDI+ unit yet). You may be prompted to install a driver. After a few moments the screen the yellow message area should say 'CONNECTING' and finally 'WAITING FOR CDI+' (earlier versions say 'NO COMMS FROM CDI+'). This means that the software is ready and waiting for the CDI+ to be connected.

If the application stops on 'INITIALISING' for more than a few minutes, then the cable driver needs installing. Refer to the readme for how to install the driver.

Now plug the cable into the car and switch the ignition on. The on screen tacho will sweep (if enabled) and the yellow message area will say 'CONNECTED'.

Switch the ignition on/off a few times whilst watching the screen to see the tacho sweep. This is indication that the software is communicating with the CDI+ unit correctly. Also observe the green flashing leds in the USB connector.

Note: The USB cable can be used with standard USB extension cables if you need to be further from the car.

Software Features.

With the car ignition on or with the car running, you can access and change the features of the unit. We recommend, however, that the car is returned to idle whilst changing parameters. Some parameters are 'locked out' when the engine is above 1200 RPM as a safety feature. The GUI may appear 'slow' to respond during lock out.

The following is a screen shot of the main user interface:

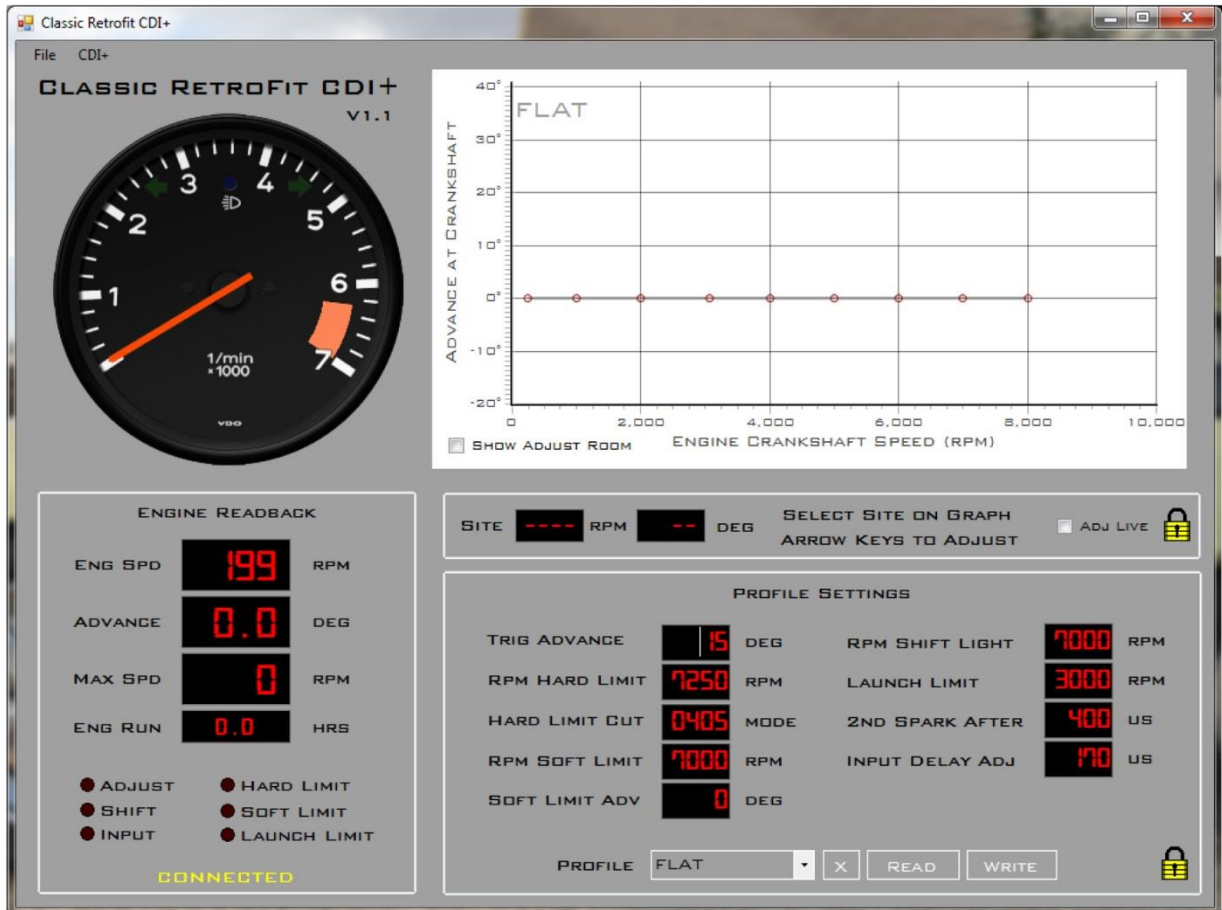

There are four main areas:

- Live Tacho
- Live Engine Readback
- Profile Settings
- Advance Curve Plot

Live Tacho



The live tacho displays the engine RPM in real time. It can also indicate other parameters when in test or setup mode discussed later.

Note that when in normal mode, the tacho displays the true RPM from the engine. This may not exactly match the car tacho unless calibration is performed. Calibration is discussed later in 'Jogwheel function'.

Live Engine Readback

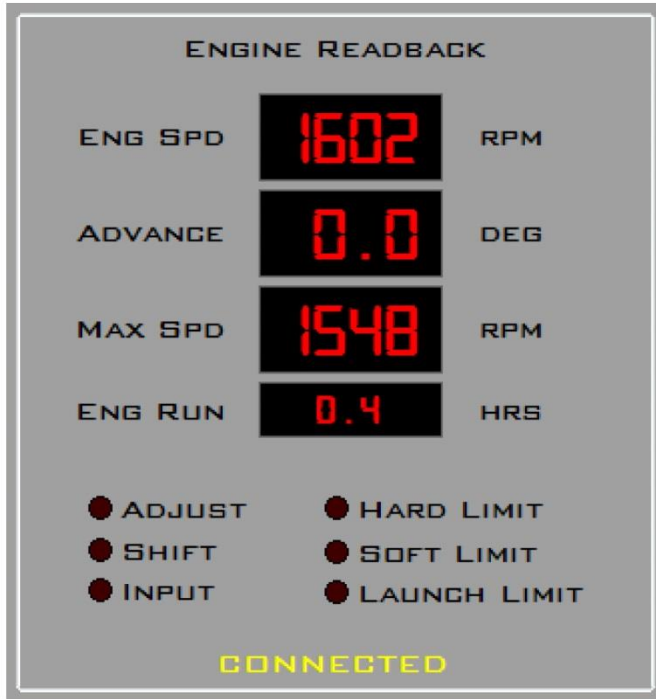

This section contains the following real time indicators:

- Engine speed (RPM)
- Advance being applied
- Maximum engine tell tale. Can be reset by clicking on the display
- Engine Running Hours.

This section contains the following real time flags:

- Adjust. Illumination indicates that the unit cannot apply the requested advance and that the distributor must be adjusted for more advance. See 'adjust room' in the Advance Curve section.
- Shift. This replicates the state of the shift light output (red/black wire).
- Input. This replicates the state of the input (yellow/black wire)
- Hard Limit. Indicates that hard limiter is active.
- Soft Limit. Indicates that soft limiter is active.
- Launch Limit. Indicates that launch limiter is active.

Profile Settings

Parameter	Value	Unit
TRIG ADVANCE	32	DEG
RPM HARD LIMIT	6250	RPM
HARD LIMIT CUT	0405	MODE
RPM SOFT LIMIT	6000	RPM
SOFT LIMIT ADV	10	DEG
RPM SHIFT LIGHT	5800	RPM
LAUNCH LIMIT	3000	RPM
2ND SPARK AFTER	400	US
INPUT DELAY ADJ	170	US

PROFILE: X READ WRITE

A group of settings is called a profile. The name of the currently selected profile is displayed in the 'Profile' box. Multiple profiles can be stored in the software but only one can be active in the CDI+ unit at any one time. You can store as many profiles as you like. It is useful to name a profile in a sensible way, perhaps the engine build number or vehicle registration. A profile contains the advance graph points as well as the items in 'Profile Settings' box shown above.

In the folder where the software is installed is a text file called Cdi.ini - all of your profiles are stored in this file. You can take a copy of this file to keep your profiles safe. It is also possible to create profiles by hand by editing the file in Notepad.

CDI+ units are shipped with a profile which has standard settings and a completely flat advance curve.

When you first start the software, it is good practice to read the actual profile from the CDI+ unit before you start changing parameters....

Reading a Profile from the CDI+ unit.

Before you fetch profile settings from the CDI+ unit decide whether you want to overwrite an existing profile or create a new one, then..

If you want to read settings into an existing profile, select the profile name and press 'READ'.

<or>

If you want to read settings into a new profile, type a new profile name and press 'READ'.

Creating a new Profile.

To create a new profile, simply overtype the profile name with a new name and press 'WRITE'. You will be prompted to save the profile and whether you want to write the setting to the unit. If you are using the software without a connection to the CDI+, answer 'No' to the second prompt.

You can use this method to create copies of the profiles, simply by typing a new name and pressing 'WRITE'.

Deleting a Profile.

To delete a profile, press the 'X' button. A prompt will ask for confirmation.

Settings in Detail

Trig Advance

The amount of advance in engine degrees that the distributor should be set to. See Adjust Room in the following section for a detailed explanation of this setting.

Rpm Hard Limit

The RPM at which to apply the ignition cut scheme chosen in the Hard Limit Cut setting.

Hard Limit cut

The 'scheme' to apply the spark cutting. The CDI+ will cut 'X' sparks out of 'Y'. The left two digits are X, the right two are 'Y'. For example '0405' means cut 4 sparks out of every 5. On a six cylinder engine, this gives a good result whilst still igniting fuel on a cyclic basis, thus preventing cylinder wash.

Rpm Soft Limit

The RPM at which to apply the advance chosen in the Soft Limit Adv setting.

Soft Limit Adv

The fixed absolute advance to set when the engine exceeds Rpm Soft Limit. E.g. for a 'full control' map, you could set the advance to 10 degrees if the RPM exceeds 6500. In an 'overlay' map it is likely that this value is negative. E.g -15 degrees above 6500 would reduce the current distributor advance by 15 degrees. If the distributor was giving 25 degrees with weights/springs, the resultant advance would be 10 degrees.

The soft limiter can give a noticeable 'hint' to the driver to shift by a subtle loss in power. This feels different to the hard limiter which is more abrupt.

Rpm Shift Light

The shift light will flash if the engine RPM exceeds this value.

Launch Limit

Combined with the yellow/black input, this can be used to achieve a race launch control function. When the yellow/black input is grounded and the engine RPM is below 1200, the CDI+ will enter launch mode (indicated by a 3 second interval pulse of the shift light). In this mode, the engine will be held at the specified RPM using the hard limiter. The limit will be disengaged when the input is removed from ground.

2nd Spark After

The CDI+ unit delivers 2 sparks for every fuel ignition right up to 10,000 RPM. This setting specifies the time between each of the sparks. The default value is 400us (0.4ms) which is suitable for most applications. General consensus is that fuel takes approx 1.0 - 1.5 ms to burn. To have another spark after the first aids the combustion during this time.

Although the evidence is anecdotal at time of writing, the CDI+ has cured many cases of hesitation and engine pick-up and we believe this is down to the second spark providing 'back up' to the combustion process.

[Note: Having the second spark too close (e.g. < 300us) can cause the second to extinguish the first as is not recommended]

Input Delay Adj

There is a constant amount of time for the points (or VR signal) to propagate through the electronics of the CDI+. We have also seen some cases where the VR (on SCs) have slightly different propagation delays. The value entered here can compensate for variations in the input delay. Usually this value is set to 170us. If you have any reason to think that your CDI+ is not applying the correct advance, please contact us for information about how to calibrate against your vehicle.

Advance Curve Plot

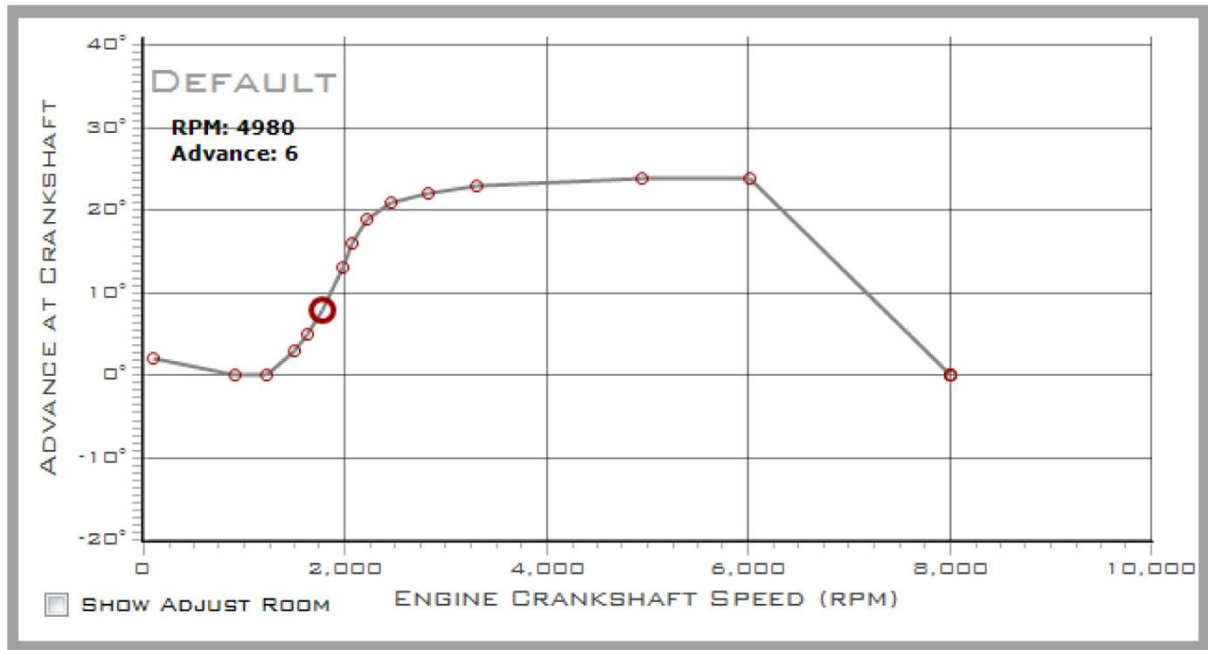

The graph shows the active ignition curve for the selected profile. The red circles show the 'sites' that can be adjusted using the mouse or cursor keys. There can be a maximum of 20 sites. Sites can be added or deleted using the right mouse button. The graph must be 'unlocked' by pressing the padlock before editing is allowed.

As shipped, the unit will have a 'flat' curve. All sites are set to zero advance. The curve can be defined by moving the sites around using the mouse. Use more sites where you need a smoother curve (coming off idle for example).

The profile selected is shown in the top left corner (e.g. DEFAULT above)

The area shown below also indicates the values at the site selected and allows adjustment using the arrow keys on the keyboard. The selected site has a large circle on the graph.

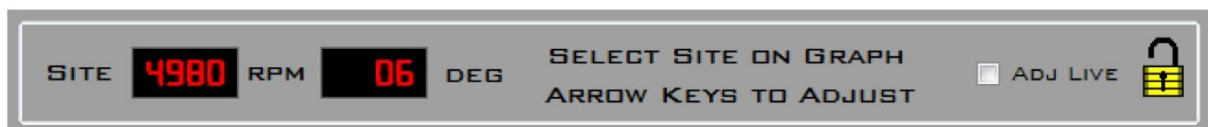

Normally, new curve settings are not sent to the unit until the 'WRITE' button is pressed, however, if the 'ADJ LIVE' tick box is checked, the settings will be sent immediately. This is useful for live adjustments on a rolling road or dyno when the engine is running. Care must be taken using this feature for obvious reasons! It is normal for the engine to hesitate whilst each setting is written. A slight misfire will be heard.

Whilst the CDI+ is connected a red tracer on the graph will always show the advance that is being applied in real time. You can use this to verify that the advance in the unit is the same as that shown on the screen.

Adjust Room

The CDI+ uses a microprocessor to calculate the exact time to fire the spark depending on the engine RPM and the advance required. In order to do this it must be able to have the distributor trigger signal before the spark is actually required.

[The way the CDI+ achieves advance is to receive the trigger signal from the distributor 'early' and then delay the firing of the coil according to the advance curve. To get the early signal we must rotate the distributor further in advance. We call the value for the distributor rotation 'TRIG ADVANCE'. The angle of advance at the distributor should be half that of the value of TRIG ADVANCE.]

Now, let's say the TRIG ADVANCE is set at 15 degrees - it should be clear that any advance in excess of 15 degrees would not be possible as the spark would have to happen before the trigger. In addition, there are other delays that compound the time required by the unit, read on...]

The total amount of time required we call the 'adjust room'. The adjust room required is a function of TRIG ADVANCE, the amount of advance required and also the input delay through the points and electronics. All of these combine to form an area that is potentially unreachable on the graph. This can be displayed on the graph using the 'show adjust room' checkbox. If the area is breached the 'ADJUST' flag will also be illuminated. If this happens, then the distributor will physically need turning further in the advance direction and the TRIG ADVANCE setting changed to match. In practice, it is not really an issue as most cars do not require more than about 30 degrees. If more than this was required, it just needs more physical advance on the distributor. In extreme cases this may require turning the distributor one tooth on the drive gear.

Ignition timing schemes.

There are two ways to use custom ignition timing. We call them Overlay and Full Control mode.

Overlay mode.

In overlay mode, the distributor weights and springs are used to control the timing just as they were originally. The CDI+ unit is then used to 'overlay' an additional advance curve on top of the weights

and spring curve. Overlay mode can be a good choice if it is difficult to lock the distributor or you are worried about rotor phasing for narrow rotor arms.

A typical overlay map is shown below:

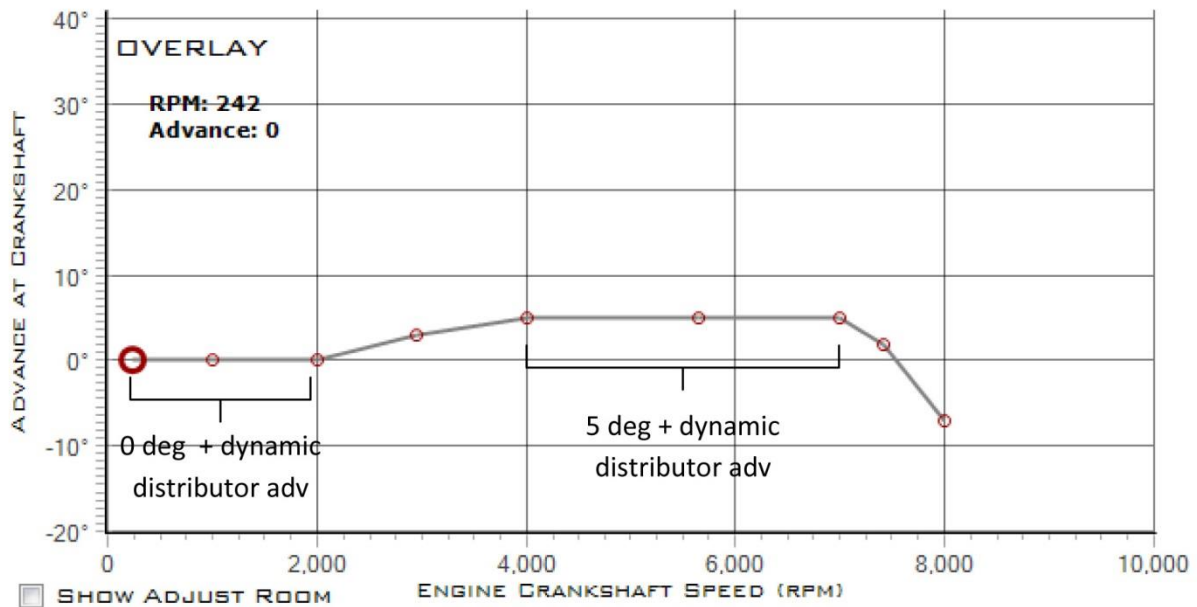

At each RPM, the advance at that point will be added (or subtracted) to the advance already given by the distributor weights/springs.

In this example, the advance will be as per distributor up to 2000 RPM (as the overlay is 0).

At 4000 - 7000 RPM the overlay will add 5 degrees to the distributor advance. Say the distributor advance was 18 degrees, adding the overlaid 5 would result in a total advance of 23 degrees.

At 7500 RPM, the overlay goes negative, meaning that this amount will be subtracted from the distributor advance. E.g. if the overlay is -8 degrees at 8000 RPM and the distributor is giving 25 degrees, the resultant advance will be 17 degrees.

Full Control mode.

In Full Control mode, the distributor weights and springs are **physically locked**. The CDI+ is in complete control of the timing. If you have a 6 pin unit we can supply a brass locking collet, please refer to the details towards the end of this manual on how to install this.

A typical full control map is shown below:

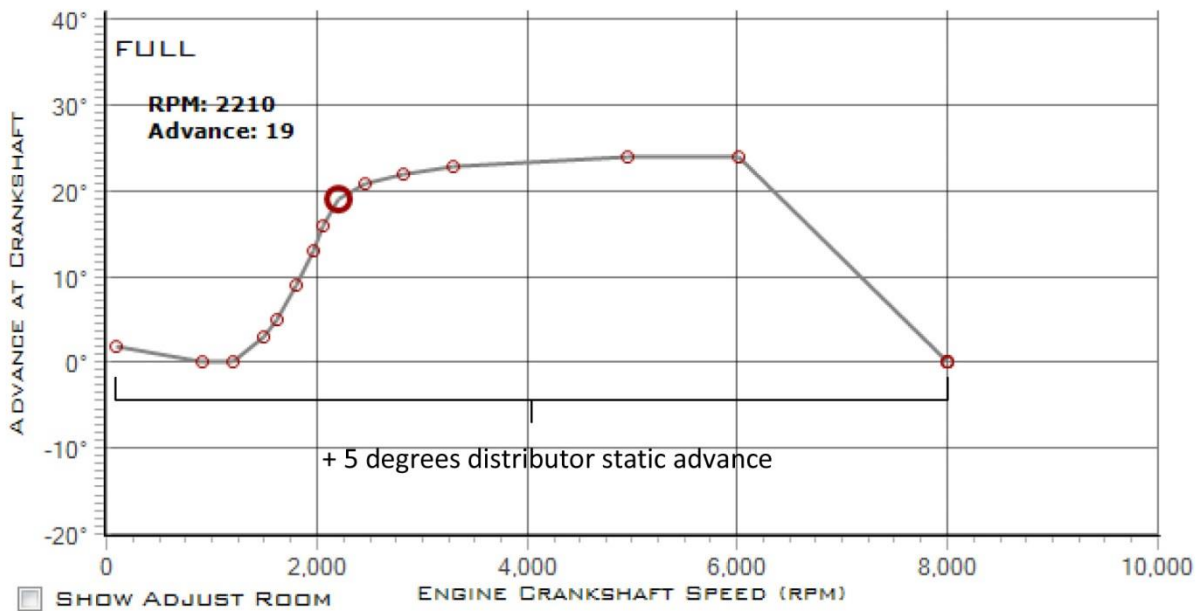

The total ignition timing is controlled completely by the unit. Remember though, that the static timing of the distributor is still offsetting these values.

For example, on an SC, the static timing at idle is set to 5 degrees BTDC. Using the graph above, the advance shown is 0 on the graph at 1000 RPM. This means that the total advance at 1000 RPM is 0 + 5 degrees. At 6000 RPM, the graph shows 24 degrees but the total timing will be 29 (+ 5 for the static timing).

If you are doing full control it is best to start with the published map from Porsche and enter that into the graph.

A typical Porsche ignition map.

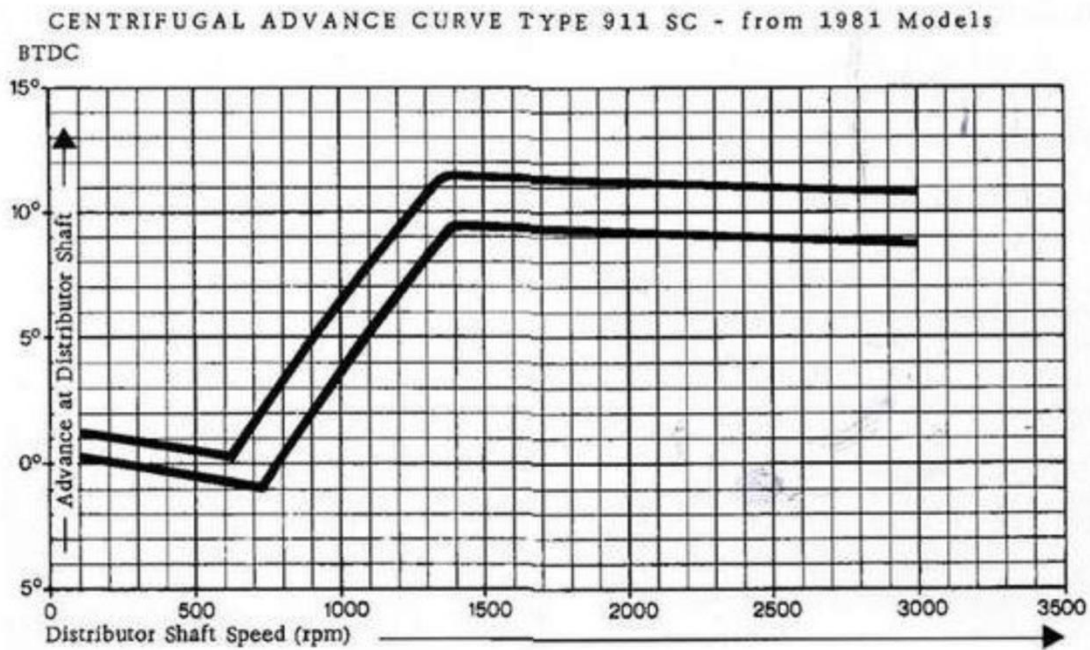

Note, for almost all Porsche published graphs:

- 1) both the degrees and RPM are with respect to the distributor. Both values must be x2 to get engine degrees and RPM.
- 2) The static timing is not included on the graph. In this case an SC is set to 5 degrees BTDC so 5 degrees offset must be added to every point on the graph.

Vacuum Advance.

The vacuum advance fitted to some Bosch distributors is a complete separate mechanical assembly and will still function with the CDI+ as Porsche intended.

Distributor Locking Collet

The Bosch distributor fitted to SC and Turbo models can be locked without taking it out of the car using our locking collet. The collet has an internal M6 thread that is used to insert /extract it from the distributor spindle. We supply an M6 screw which makes a handy insertion/extraction tool.

1. Remove the distributor cap, rotor arm and dust cap.
2. Remove the felt pad from inside the spindle, and the existing M4 screw beneath it.
3. Use the insertion tool to put the brass collet into the spindle. Unscrew the tool.



4. Fit the longer M4 screw provided but do not tighten yet.
5. Turn the distributor star wheel anti-clockwise and hold whilst tightening the screw with your other hand:



6. Verify that the star wheel is locked in position.

Note: You have now locked the star wheel in its fully advanced position. This is effectively advancing the trigger point by 20 engine degrees. If you have previously been running in overlay mode, you will need to enter a full ignition map, set the TRIGGER ADVANCE to a larger number (typically ~32) and retune the engine.

You will find that even if your TRIGGER ADVANCE was set to 15 degrees in overlay mode and you need 32 degrees in full control mode, you don't need to move the distributor very much. Why? Because the rotation of the star wheel just gave you another 20 engine degrees TRIGGER ADVANCE.

This should help to explain:

Mode	TRIGGER ADVANCE (software setting)	DISTRIBUTOR ADVANCE REQUIRED (to match software setting)
OVERLAY	15 deg	$15 / 2 = 7.5$ deg
FULL CONTROL	32 deg	$(32 - 20^*) / 2 = 6$ deg

* star wheel advance

Advance Timing Results

Record your ignition advance readings here:

RPM	Stock CDI Advance	CDI+ Advance	Notes
1000			
2000			
3000			
4000			
5000			
6000			

Troubleshooting.

Classic Retrofit tests every unit shipped on a test kit with a real distributor, coil and spark plugs. We do our best to ensure that they are ready to go on to a vehicle. However, every car is different and may have had 'modifications' or wiring changes.

Here are a list of common issues that we have found during installation and test.

Symptom	Reason	Remedy
Car wont idle smoothly	Points bounce	Fit new points. Service distributor.
Car wont idle, cuts out, rev counter erratic.	Bad ground	Review earth straps and spade connectors on loom. 3 pin units use the case for ground and must have earth straps fitted.
Idle too high	Too much advance	Re time engine.
Idle too low	Too little advance	Re time engine. As shipped, units require about 7.5 degrees more rotation on the distributor than the Bosch CDI.
Car wont rev beyond a certain RPM	Rev limiter active	Connect laptop and set rev limiter.
Car shunts (cuts out on applying power)	Second spark time set too low. Second spark is extinguishing first spark.	Increase the 2nd spark time. 400 us should work for most applications.
Timing appears less/more that advance curve indicates	Input delay time needs adjustment.	For a known advance at a higher RPM (say 5000 RPM) adjust the delay time to correct timing shown on timing light.

Disclaimer.

	<p>This equipment must be installed by an auto electrician or persons of equivalent level of competence. Failure to follow the installation procedure can result in damage to the vehicle, its wiring harness and injury.</p> <p>The real time ignition timing provided by CDI+ unit has been independently validated on an engine dyno. The unit has been collectively bench and road tested in excess of 20000 miles.</p> <p>Classic Retrofit accept no responsibility for any damage caused by detonation.</p>
---	---